

**5** OUTBOARD  
YEARS  
warranty

FOR LEISURE USE ONLY  
Selva 50 hours and conditions  
see your Dealer for more  
information



**SELVA**<sup>TM</sup>



Open Elegance  
Line

Open Classic  
Line

Tiller Line

Sun Deck  
Classic Line

Cruiser  
Line

# BOATS WITH OUTBOARD MOTORS



**f** Selva Marine

# BOATS WITH OUTBOARD MOTORS

Selva Marine Engines come with a Five-Year Limited Warranty. Certain conditions and exclusions apply including professional and commercial use.

**5** OUTBOARD  
YEARS  
warranty

FOR LEISURE USE ONLY  
Subject to terms and conditions  
in your Dealer for more  
information



## Open Elegance Line

1 MODEL 5,7 m

P. 3



## Open Classic Line

2 MODELS 5,3 and 5,6m

P. 5



## Tiller Line

3 MODELS from 4 to 4,8m

P. 8



## Sun Deck Classic Line

3 MODELS from  
5,7m to 7m

P. 12



## Cruiser Line

3 MODELS from  
5,9m to 7,1m

P. 18



**Open Elegance  
Line**

MODEL  
**5.7 ELEGANCE**

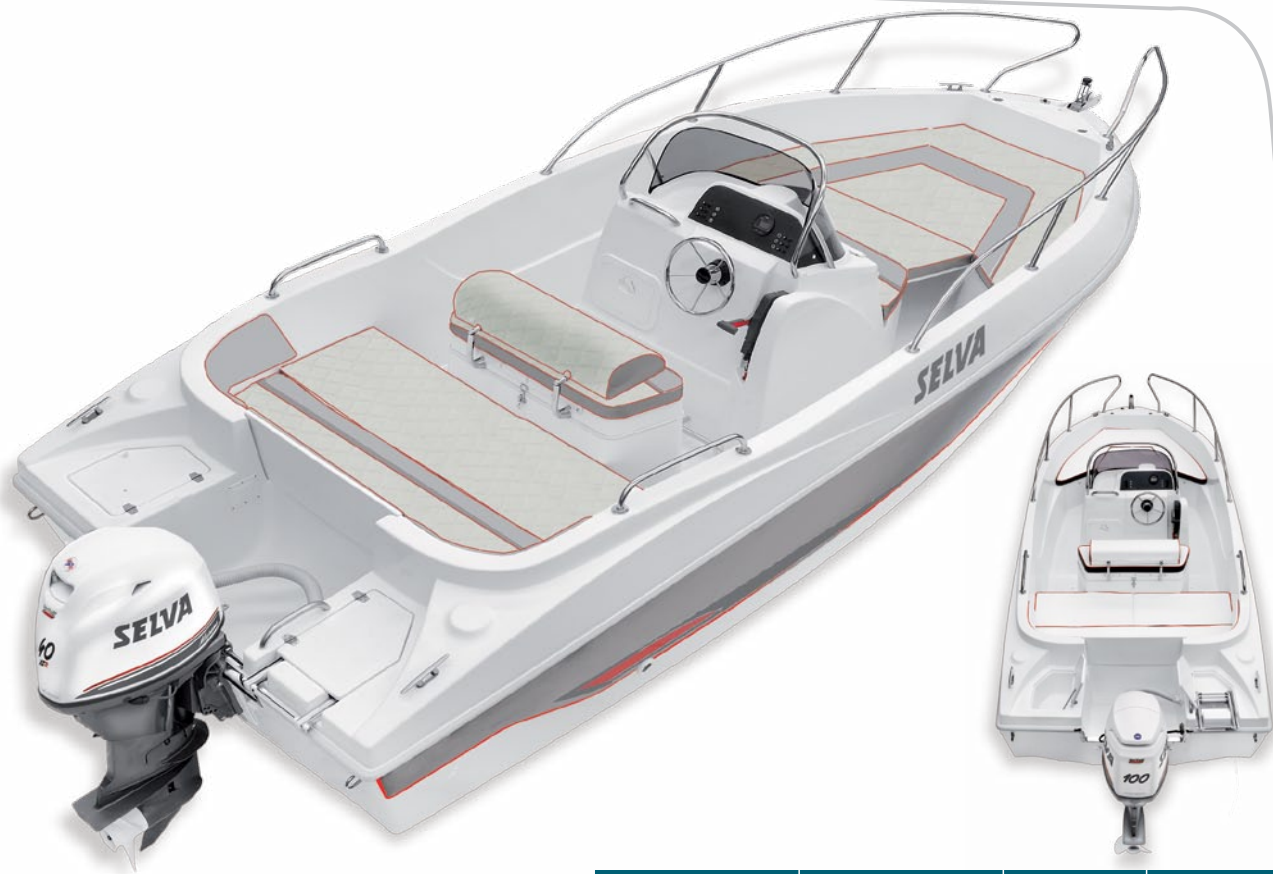

Max length (cm)	Max beam (cm)	Dry weight (kg)	People carrying capacity
566	229	750	7

Model	5.7 ELEGANCE
Max length (cm)	566
Max width (cm)	229
Approx. dry weight (kg)	750
Max applicable power (kW/hp)	86 (115)
Recommended power (hp)	40 / 100
People carrying capacity	7
Motor shaft version	Long
Max carrying load (people, standard equipment, engine) (kg)	812
Design category	C

Model	5.7 ELEGANCE
Engine installation	S
Complete electric plant	S
Rev counter	S
Console with handrails and grab handle in stainless steel, stainless steel steering wheel, single lever, single cable steering, anti reflection windscreen, glove-box, switch panel, front seat with cushion and backrest cushion, footrest for the pilot and copilot in stainless steel.	S
Locker under console for possible installation of toilets with hatch access and portholes for ventilation	S
Navigation lights	O
WC	O
Compass	O
Side holdall pockets	S
Stern bench with compartment below	S
Tilting driver's seat backrest, with stowage below, for seated or upright driving	S
Stainless steel bow pulpit	S
Self-draining anchor locker with cover	S
Anchor capstan	S
Electric anchor winch	O
Bilge pump	S
Stainless steel cleats	S
Stainless steel mooring rings	S
Complete range of cushions	S
Support for table	S
Bow sundeck extension with cushions	S
Aft sundeck extension with cushions	S
Mooring cover	O
Sun awning	O
Built-in fuel tank with blower, solenoid valves, fuel level gauge and filter on delivery	S - 120 lt
Telescopic stainless steel boarding ladder in stern locker	S
Live bait tank	S
Hydraulic steering system	O
Water tank with shower	O - 50 lt.

S = Standard  
O = Optional

For information on engines in packages with **OPEN ELEGANCE LINE** boats please see the **Selva Marine** outboard engine catalogue.

The data in these tables are to be considered as approximate and **Selva S.p.A.** reserves the right to modify the technical characteristics, materials, construction, weights, colours, graphics etc. without any forewarning or obligation.

The specifications given in this table are determined in accordance with the regulations in force at the time of preparation of the catalogue and may have to be modified. Please request confirmation of the data at time of purchase.

**Open Classic**  
**Line**

MODEL  
**D.5.6**

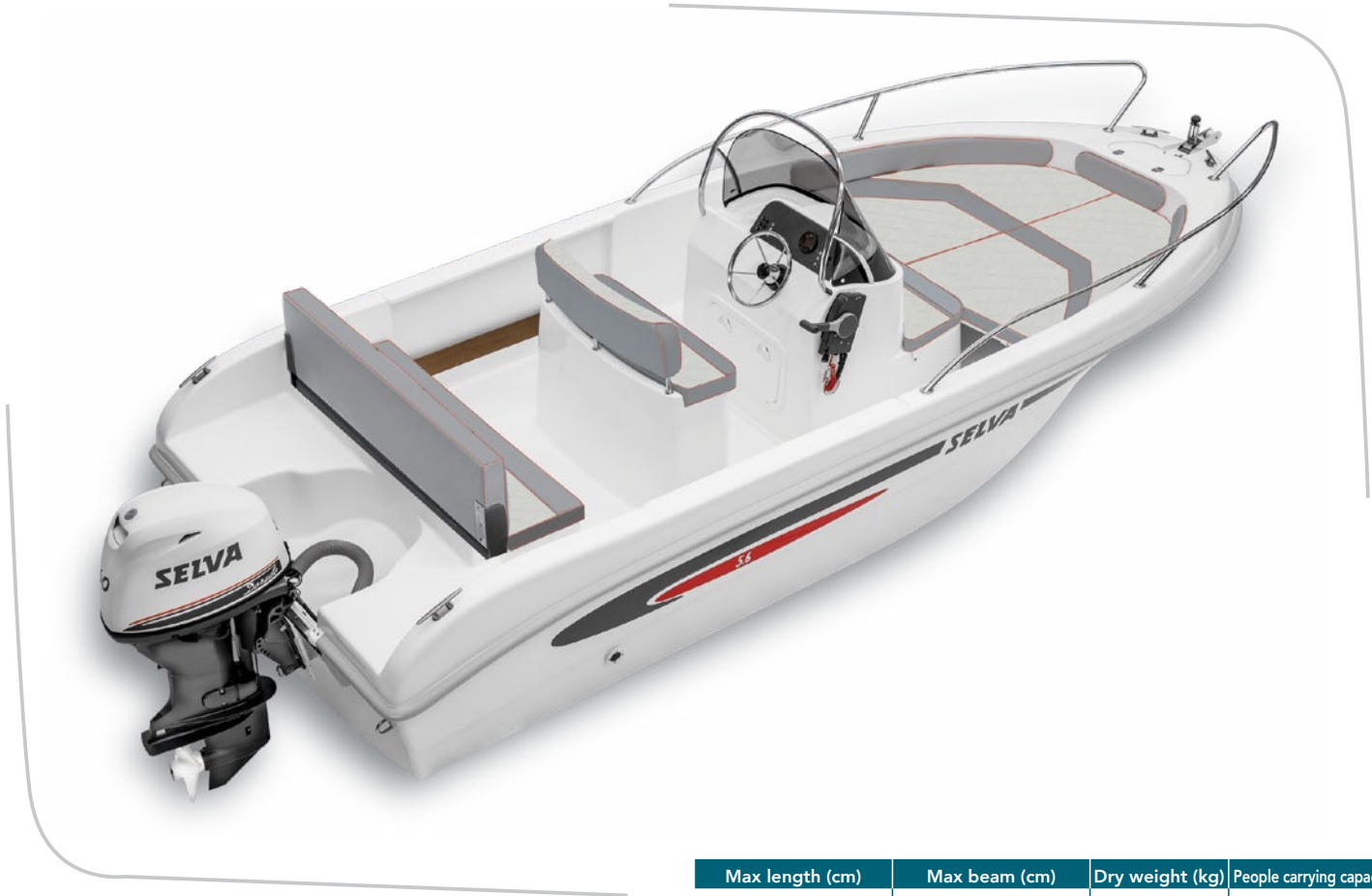

Max length (cm)	Max beam (cm)	Dry weight (kg)	People carrying capacity
550	232	620	7

MODEL  
**D.5.3**

**Open Classic  
Line**

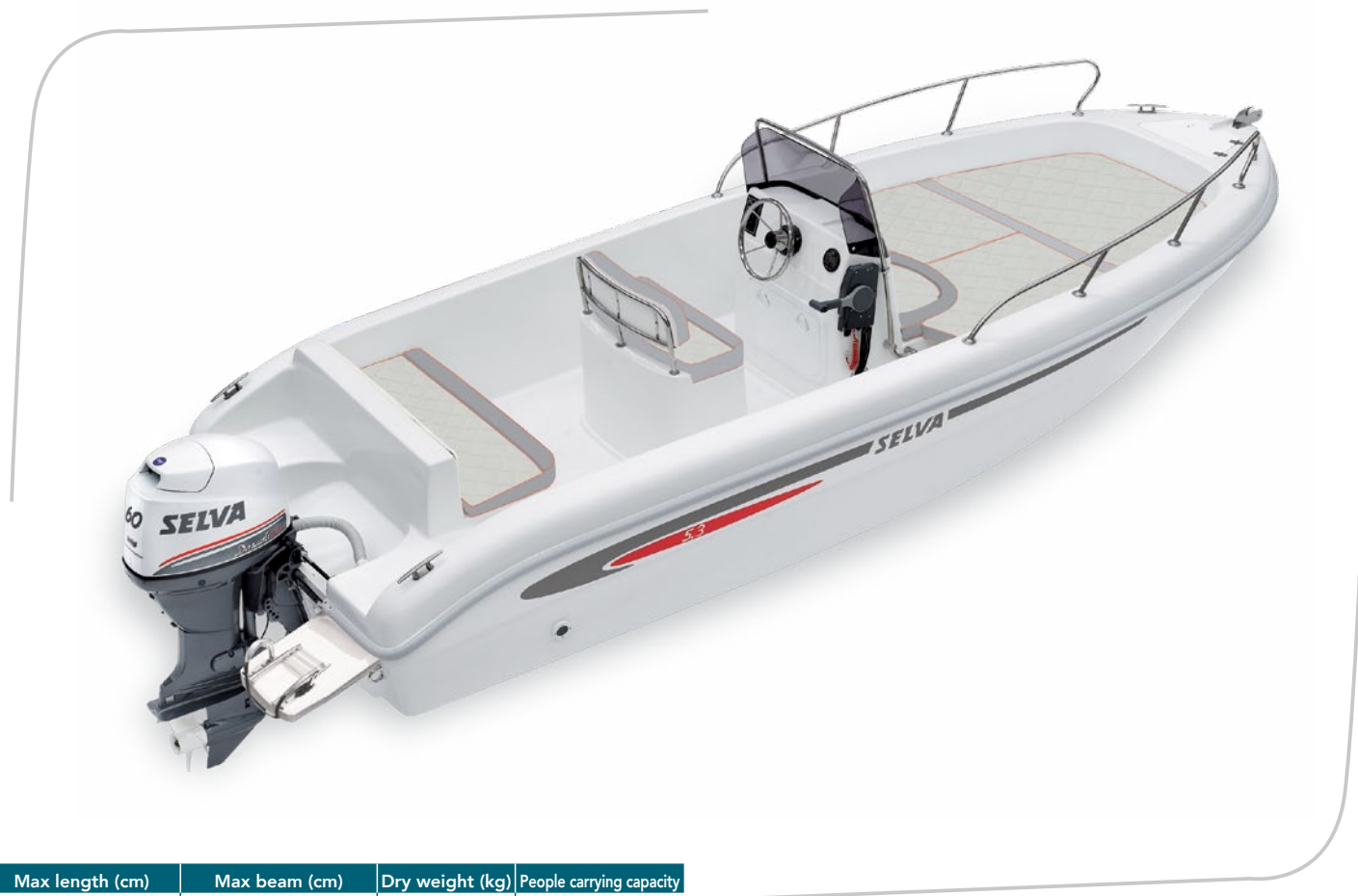

Max length (cm)	Max beam (cm)	Dry weight (kg)	People carrying capacity
527	210	480	6

Model	D.5.6	D.5.3
Max length (cm)	550	527
Max width (cm)	232	210
Construction height (cm)	113	95
Approx. dry weight (kg)	620	480
Max applicable power (kW/hp)	85 (115)	58,8 (80)
Recommended power (hp)	60/100	40/60
People carrying capacity	7	6
Motor shaft version	Long	Long
Max carrying load (people, standard equipment, engine) (kg)	775	690
Design category	C	C

Model	D.5.6	D.5.3
Motor installation	S	S
Complete electric plant	S	S
Rev counter	S	S
Complete console <sup>(1)</sup>	S	S
Navigation lights	O	O
Compass	O	O
Side holdall pockets	S	O
Stern bench	S	S
Driving seat with backrest and locker underneath	S	S
Stainless bow pulpit	S	S
Self-draining anchor locker with cover	S	S
Anchor winch	S	S
Electric anchor winch	O	O
Bilge pump	S	S
Stainless steel bollards	S	S
Stainless steel mooring rings	S	S
Complete set of cushions	S	S
Bow sundeck extension with cushions	S	S
Support for table	S	S
Mooring cover	O	O
Sunshade awning	O	O
Integrated fuel tank with solenoid valve and level indicator	O - 90 lt	O - 55 lt.
Stainless steel folding swim ladder	O	O
Hydraulic steering system	O	O
Water tank with shower plant	O - 50 lt.	O - 50 lt.

S = Standard  
O = Optional

<sup>(1)</sup>= Console with: stainless steel handrail, stainless steel steering wheel, single lever remote control box, single cable wheel house, sun deflecting windscreen, door with lock, switchboard with switches front seat with cushion and access to the locker below plus backrest cushion.

For information on engines in packages with **OPEN CLASSIC LINE** boats please see the **Selva Marine** outboard engine catalogue.  
The data in this table are to be considered as approximate and **Selva S.p.A.** reserves the right to modify the technical characteristics, materials, construction, weights, colours, graphics etc. without any forewarning or obligation.  
The specifications given in these tables are determined in accordance with the regulations in force at the time of preparation of the catalogue and may have to be modified. Please request confirmation of the data at time of purchase.

MODEL  
**T.4.8**

**Tiller Line**



Max length (cm)	Max beam (cm)	Dry weight (kg)	People carrying capacity
480	180	280	5



**Tiller Line**

MODEL  
**T.4.5**



Max length (cm)	Max beam (cm)	Dry weight (kg)	People carrying capacity
450	163	220	4

MODEL  
**T.4.0**

**Tiller Line**



Max length (cm)	Max beam (cm)	Dry weight (kg)	People carrying capacity
399	170	220	4

Model	T.4.8	T.4.5	T.4.0
Max length (cm)	480	450	399
Max width (cm)	180	163	170
Approx. dry weight (kg)	280	220	220
Max applicable power (kW/hp)	22,1(30)	18,4 (25)	18,4 (25)
Recommended power (hp)	15/25	9,9/20	9,9/20
People carrying capacity	5	4	4
Motor shaft version	Long		
Max carrying load (people, standard equipment, engine) (kg)	530	425	425
Design category	C	C	C

S = Standard  
O = Optional  
N = Not available

Model	T.4.8	T.4.5	T.4.0
Paddle oars	O	O	O
Stern bench with locker	N	S	S
Side bow benches + lockers with closure	S	N	N
Bow locker with closure	S	S	S
Central lockers with cover	S	S	S
Extension bench for central seat	N	S	S
Fender profile	S	S	S
Stainless steel mooring rings	S	S	S
Stainless steel handrail	S	S	S
Stainless steel anchor winch	S	S	S
Stainless steel grommet	S	S	S
Stainless steel bollard	S	S	S
Mooring cover	O	O	O
Swim ladder	O	O	O
Stainless steel bow hand rail	O	N	N
Stainless steel framed Bimini top	O	O	O
Solid wood floor cover	O	O	O
Cushion set (only for the T4.8, sundeck extension)	O	O	O
GRP console	O	O	O

For information on engines in packages with **TILLER LINE** boats please see the **Selva Marine** outboard engine catalogue.  
The data in this table is to be considered as approximate and **Selva S.p.A.** reserves the right to modify the technical characteristics, materials, construction, weights, colours, graphics etc. without any forewarning or obligation.  
The specifications shown in these tables are determined in accordance with the regulations in force at the time of preparation of the catalogue and may have to be modified. Please request confirmation of the data at time of purchase.

MODEL  
**SD.7.0 CABIN**

**Sun Deck**  
Classic Line



Max length (cm)	Max beam (cm)	Dry weight (kg)	People carrying capacity
700	255	1400	9





### CABIN

The cabin is equipped with a double bed complete with mattresses, a perimeter storage pocket, wooden furniture, porthole and curtain of courtesy.



### WC COMPARTMENT

In the cabin is installed a compartment in which to place an eventual WC as optional

### COCKPIT

The cockpit area can be set up into a sunbathing area or to an external sitting area



### BOW NOSE

The bow nose is designed for be able to install an electric winch (optional).



## CONSTRUCTION DETAILS

MODEL  
**SD.6.7 CABIN**

**Sun Deck**  
Classic Line



Max length (cm)	Max beam (cm)	Dry weight (kg)	People carrying capacity
665	250	950	8

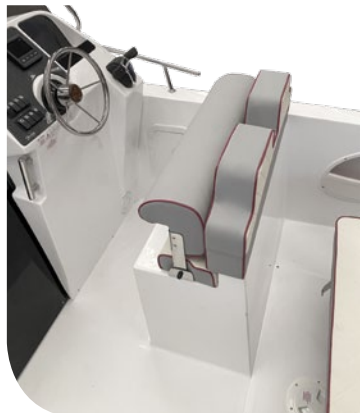
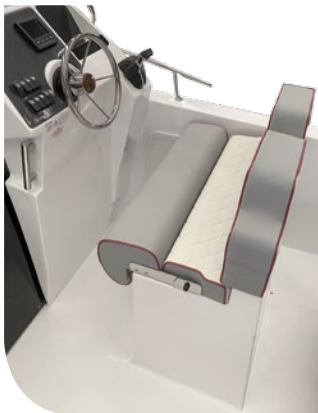

### DRIVER'S HELM POSITION

The dashboard, appropriate to the boat can easily accommodate all the onboard instrumentation and engine controls.

The tilting pilot's seat allows for both a seated or upright driving position.

The cabin access door is sliding for better use.



### COCKPIT

The cockpit area can be set up into a sunbathing area, to an external sitting area or left as "open space", with extraordinary room available.



### CABIN

The cabin is equipped with a double bed complete with mattresses, a perimeter storage pocket, spotlights, porthole and curtain of courtesy.



## CONSTRUCTION DETAILS

MODEL  
**SD.5.7 CABIN**

**Sun Deck**  
Classic Line



Max length (cm)	Max beam (cm)	Dry weight (kg)	People carrying capacity
562	229	850	7



Model	SD.7.0 CABIN	SD.6.7 CABIN	SD.5.7 CABIN
Max length (cm)	700	665	562
Max width (cm)	255	250	229
Approx. dry weight (kg)	1400	950	850
Max applicable power (kW/hp)	220 (300)	112 (152)	86 (115)
Recommended power (hp)	1 x 250	1 x150	40 / 100
People carrying capacity	9	8	7
Motor shaft version	Extra Long	Extra Long	Long
Max carrying load (people, standard equipment, engine) (kg)	1305	812	812
Design category	C	C	C

#### FEATURES

Model	SD.7.0 CABIN	SD.6.7 CABIN	SD.5.7 CABIN
<b>CABIN</b>			
Cushions with removable covers	S	S	S
Installation possibility chemical WC	S	S	S
Chemical WC	O	O	O
Electric WC	O	O	N
Side holdall pockets	S	S	S
Cabin lighting	S	S	S
Door with lock and latch	S	S	S
<b>COCKPIT</b>			
Large lockers	S	S	S
Side holdall pockets	S	S	S
Bow bench with cushions	S	S	S
Support for table	S	S	O
Sink and faucet	S	N	N
Foldable inox swimming ladder	S	S	S
Steps for access to the deck	S	S	S

S = Standard  
O = Optional  
N = Non disponibile

Model	SD.7.0 CABIN	SD.6.7 CABIN	SD.5.7 CABIN
<b>EQUIPMENT</b>			
Motor installation	S	S	S
Complete electrical plant	S	S	S
Navigation light	S	S	S
Horn	S	S	S
Integrated fuel tank with solenoid valve and level gauge	S-250 lt.	S-120 lt.	S-120 lt.
Integrated fresh water tank with shower plant and pump	S - 70 lt.	S - 50 lt.	O - 45 lt.
Electric bilge pump	S	S	S
Hydraulic steering system	S	S	O
<b>DECK</b>			
Four stainless steel cleats	S	S	S
Mooring rings	S	S	S
Self draining anchor locker with cover	S	S	S
Electric anchor winch	O	O	O
Bow moulding	S	S	S
Open stainless steel pulpit	S	S	S
Deflecting windscreen	S	S	S
Complete cushion set	S	S	S
Bimini top	O	O	O
Mooring cover	O	O	O
Stainless steel foldable roll bar, with front and rear canopy	O	O	O
<b>DASHBOARD</b>			
Engine controls	S	S	S
Instrument panel	S	S	S
Tachometer	S	S	S
Fuel level gauge	S	S	O
Compass	S	S	S
Switch panel	S	S	S

For information on engines in packages with **SUN DECK LINE** boats please see the **Selva Marine** outboard engine catalogue.  
The data in this table are to be considered as approximate and **Selva S.p.A.** reserves the right to modify the technical characteristics, materials, construction, weights, colours, graphics etc without any forewarning or obligation.  
The specifications given in these tables are determined in accordance with the regulations in force at the time of preparation of the catalogue and may have to be modified. Please request confirmation of the data at time of purchase.

MODEL  
**C.7.1 CABIN PLUS**

**Cruiser  
Line**

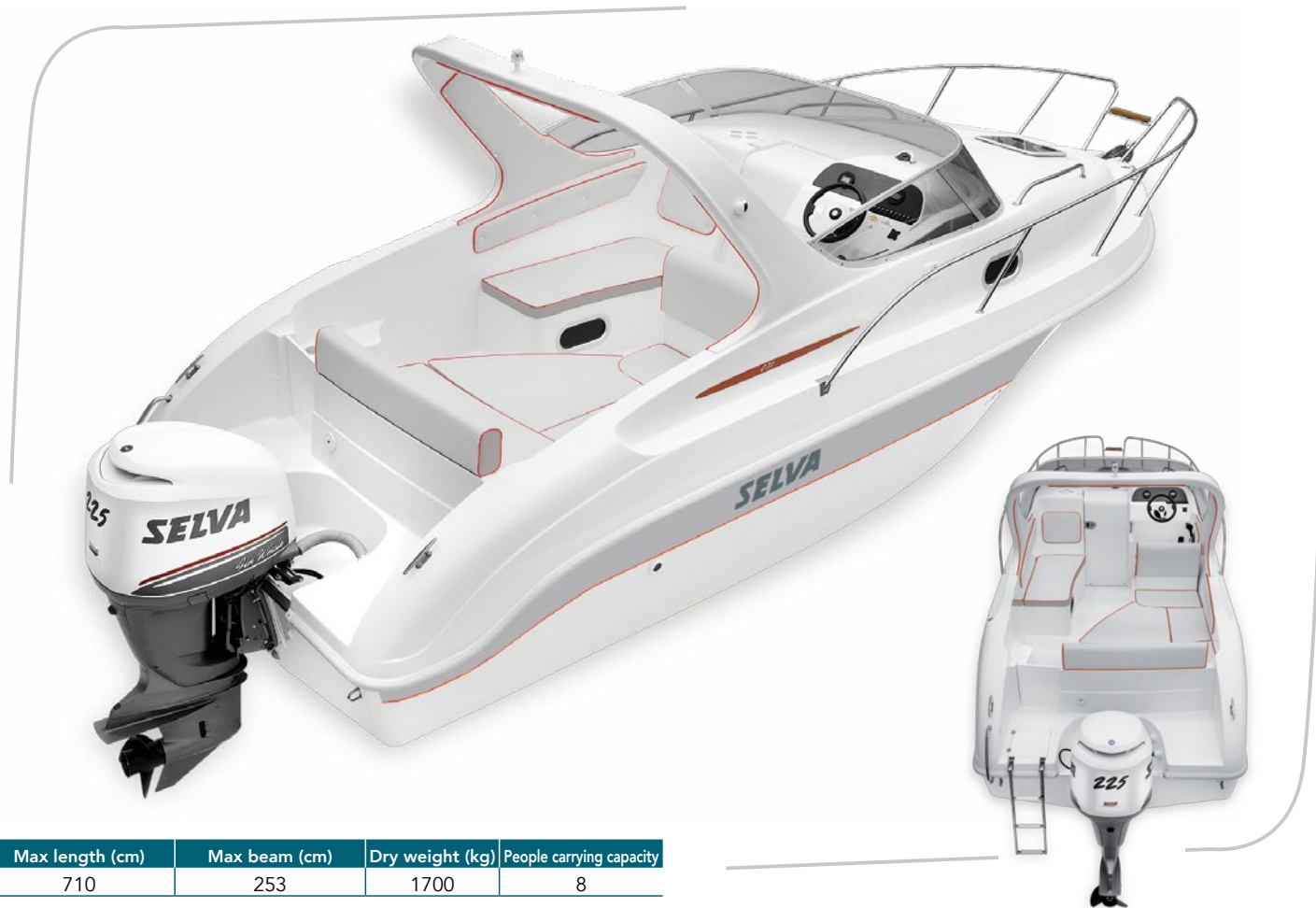

Max length (cm)	Max beam (cm)	Dry weight (kg)	People carrying capacity
710	253	1700	8



### KITCHEN AREA

The kitchen area adjacent to the bow cabin includes a cupboard, a sink with tap, a stylish wooden storage compartment and a locker below.

The stern cabin includes a double bed, porthole, curtain and spotlight.



### DRIVER'S HELM POSITION

The dashboard for this boat can accommodate the complete onboard instrumentation and engine controls. The tilting pilot's seat allows for both a seated or upright driving position. The cabin door slides for easy access.

The forward cabin includes a double bed which can be converted into a lounge area with a 'U'-shaped sofa. The fittings include a storage pocket, porthole, curtain and spotlight.



### VERSATILE STERN SEATING

The stern can be set up as a comfortable sunbathing space or an additional sitting area with table.



## CONSTRUCTION DETAILS

MODEL  
**C.6.7 CABIN PLUS**

**Cruiser  
Line**



Max length (cm)	Max beam (cm)	Dry weight (kg)	People carrying capacity
660	253	1200	7





#### **SEPARATE BATHROOM**

The bathroom is separate, with Electric WC, wash basin and wood finishes.

#### **CABIN**

The cabin is equipped with a double bed that can be transformed into a sitting room with an U-shaped sofa. Finely finished in wood and fabric.



MODEL  
**C.5.9 CABIN**

**Cruiser  
Line**

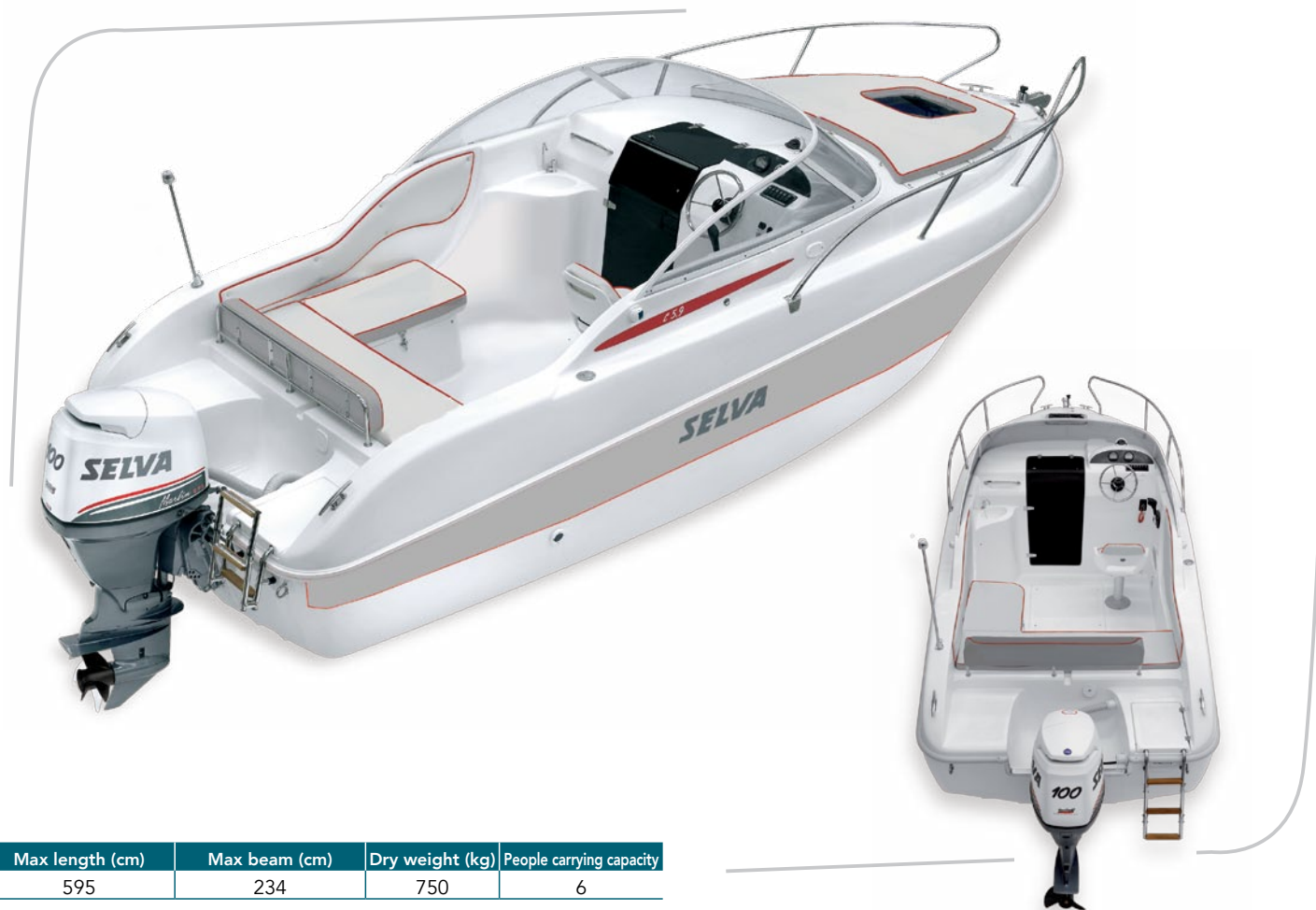

Max length (cm)	Max beam (cm)	Dry weight (kg)	People carrying capacity
595	234	750	6

Model	C.7.1 CABIN PLUS	C.6.7 CABIN PLUS	C.5.9 CABIN
Max length (cm)	710	660	595
Max width (cm)	253	253	234
Approx. dry weight (kg)	1700	1200	750
Max applicable power (kW/hp)	165,5 (225)	150 (204)	85 (115)
Recommended power (hp)	150/225	150/200	70/100
People carrying capacity	8	7	6
Motor shaft version	Extra Long	Extra Long	Long
Max carrying load (people, standard equipment, engine) (kg)	1220	845	700
Design category	C	C	C

### FEATURES

Model	C.7.1 CABIN PLUS	C.6.7 CABIN PLUS	C.5.9 CABIN
<b>FORWARD CABIN</b>			
Complete range of removable cushions	S	S	S
Wide lockers	S	S	S
Separate bathroom with electric toilet, wash basin with tap and hatch	S	S	N
Chemical WC	N	N	O
Side storage pockets	S	S	S
Cabin lighting	S	S	S
Kitchen cabinet with sink and tap, storage compartment and wood cabinet	S	N	N
Two side portholes	S	S	N
Manhole	S	S	S
Entrance with hatch access with lock and latch	N	S	S
Sliding front door with lock and latch	S	N	N
<b>DECK</b>			
Four stainless steel cleats	S	S	S
Mooring rings	S	S	S
Self-draining anchor locker with hatch cover	S	S	S
Electric anchor winch	O	O	O
Bow-roller	S	S	S
Bow boarding bridge	S	S	S
Windshield with anodised aluminium frame	S	S	S
Bow sundeck cushions	O	O	O
Integrated fibreglass roll bar and nav lights	S	S	N
Canopy cover dashboard / awning	O	O	N
Bimini	N	N	O
Full cockpit cover	O	O	O
Auxiliary engine support	O	O	O

S = Standard  
O = Optional  
N = Not available

Model	C.7.1 CABIN PLUS	C.6.7 CABIN PLUS	C.5.9 CABIN
<b>STERN CABIN</b>			
Double bed with cushions	S	N	N
Porthole with curtain	S	N	N
Cabin lighting	S	N	N
Privacy curtain	S	N	N
<b>DASHBOARD</b>			
Steering wheel	S	S	S
Integrated single-lever controls	S	S	S
Instrument panel	S	S	S
Rev counter	S	S	S
Fuel gauge	S	S	S
Compass	S	S	S
Switch panel	S	S	S
Swivel driver seat	N	S	S
Tilting pilot seat for sitting or half upright driving, folding for access to the locker underneath	S	N	N
<b>COCKPIT</b>			
Wide lockers	S	S	S
Side holdall pockets	N	S	S
Stern bench with cushions	S	S	S
Bow sundeck extension with cushions	S	O	O
Table	S	S	O
Sink and faucet	N	N	S
Kitchen area includes a cupboard, a sink with tap and a locker below	N	S	N
Locker swim ladder	S	S	S
Swimming ladder stainless steel	S	S	S
Steps for access to the deck	S	S	N
<b>EQUIPMENT</b>			
Motor installation	S	S	S
Complete electric system	S	S	S
Navigation lights	S	S	S
Horn	S	S	S
Built-in fuel tank with blower	S - 200 lt.	S - 160 lt.	S - 100 lt.
Built-in fresh water tank with level gauge	S - 70 lt.	S - 50 lt.	S - 50 lt.
Black water tank	S	S	N
Bilge pump	S	S	S
Hydraulic steering system	S	S	O

For information on engines supplied in packages with **CRUISER LINE BOATS** please see the outboard **Selva Marine** engine catalogue. The data in these tables are to be considered as approximate and **Selva S.p.A.** reserves the right to modify the technical characteristics, materials, construction, weights, colours, graphics etc without any forewarning or obligation. The specifications given in this table are determined in accordance with the regulations in force at the time of preparation of the catalogue and may have to be modified. Please request confirmation of the data at time of purchase.



**SELVA S.p.A.**

Head office and main factory:

Viale dell'Industria, 13

23037 Tirano (SO) - Italia

Tel. 0342 702451 - Fax 0342 70536

VAT Number IT 00050830140

Company Registration SO n. 00050830140 - REA n. 18382

[www.selvamarine.com](http://www.selvamarine.com)



**Q8**  **Oils**